



Designing Your Own Model Rocket

This publication is intended to be used with the Ohio 4-H project 503M *Solid-Fuel Rocketry Master*, available online at www.ohio4h.org/rocketsaway. To participate, youth should have completed 503 *Rockets Away! (Solid-Fuel Model Rockets)*, have rocketry experience comparable to what is required for other advanced-level 4-H projects, and be able to plan and complete the project on their own with minimal supervision or assistance.

The project 503M *Solid-Fuel Rocketry Master* requires a review and acknowledgment of the NAR *Model Rocket Safety Code*. The code is included in its entirety there and in this publication.

Designing Your Own Model Rocket

AUTHOR

D. Mark Ponder, Electrical Controls Designer and Model Rocket Enthusiast (since the 1970s!)

REVIEWERS

Dr. Bob Horton, Extension Specialist, Educational Design and Science Education, 4-H Youth Development, Ohio State University Extension

Savannah Ponder, M.S., Aeronautical Engineering, and Research Engineer

© 2013, The Ohio State University

Ohio State University Extension embraces human diversity and is committed to ensuring that all research and related educational programs are available to clientele on a nondiscriminatory basis without regard to age, ancestry, color, disability, gender identity or expression, genetic information, HIV/AIDS status, military status, national origin, race, religion, sex, sexual orientation, or veteran status. This statement is in accordance with United States Civil Rights Laws and the USDA.

Keith L. Smith, Associate Vice President for Agricultural Administration; Associate Dean, College of Food, Agricultural, and Environmental Sciences; Director, Ohio State University Extension; and Gist Chair in Extension Education and Leadership.

For Deaf and Hard of Hearing, please contact Ohio State University Extension using your preferred communication (e-mail, relay services, or video relay services). Phone 1-800-750-0750 between 8 a.m. and 5 p.m. EST Monday through Friday. Inform the operator to dial 614-292-6181.

Contents

Introduction.....	2
Model Rocket Safety Code	3
Design Options	
Clustering	5
Staging.....	7
Fins	10
Nose Cone Options	12
Base Options	13
Electronics.....	14
Stability.....	15
Center of Gravity.....	15
Center of Pressure (CP) or Point of Pressure	15
Swing Test for Stability.....	17
Additional Information for Review	
Model Rocket Motors	18
Adhesive Types	18
Finishing	20
Plagiarism	21
Sample Rocket Projects	22
Additional Resources.....	30

Introduction

Designing your own model rocket can be completed in many different ways. This booklet guides you through general steps and provides some options to consider as you begin.

One of your first decisions is whether you design your own rocket by modifying an existing rocket model or start from scratch by assembling individual pieces and parts.

Modifying an existing rocket model includes changing the manufacturer's performance specifications or the rocket's exterior. Options for modifying a rocket model include increasing engine size, adding stages, or adding engines to create an engine cluster. More information on some of these options is provided within this book.

When starting from scratch and assembling individual parts, you have complete control of what your rocket looks like.

This type of rocket design building is typically done by purchasing a bulk parts kit package or by "kit bashing."

Designer Special packages include a mixture of different

model rocketry pieces and are commonly sold at the same stores as manufactured kits. Kit bashing means combining two or more manufacturer kits to create a single, custom-designed rocket. The kits can be identical or different. If you build your rocket from scratch using the kit bashing method, be sure to keep track of which parts came from which kits. In some cases, kit bashing is the most economical path to designing your own rocket from scratch.

Regardless of the design path you pursue, the recovery system of your rocket is of your choosing—as long as it works. If your parachute deploys perfectly but your shock cord mount fails, your recovery system has failed. If you are in doubt, check your shock cord mount, add an additional layer of glue, and place another layer of paper over it.

Remember, the objective of this project is to show what knowledge you have gained and what you have learned. "Bigger is not better, but bigger is usually more expensive." There are reasons for building a larger rocket; however, a kit-bashed rocket with an A-C engine size (18mm) can easily compete with a kit-bashed rocket with a D-E engine size (24mm).

"The greater danger for most of us is not that our aim is too high and we miss it, but that it is too low and we reach it."

—*Michelangelo*

"Experience is a hard teacher because she gives the test first, the lesson afterward."

—*Vernon Law*

Model Rocket Safety Code

Regardless of what your rocket eventually looks like, you must ensure that you follow all aspects of the *Model Rocket Safety Code*. The safety code has specific guidelines regarding materials, size, and recovery systems. Pay special attention to them now so that can incorporate them into your design.

Effective August 2012

1. **Materials.** I will use only lightweight, non-metal parts for the nose, body, and fins of my rocket.
2. **Motors.** I will use only certified, commercially-made model rocket motors, and will not tamper with these motors or use them for any purposes except those recommended by the manufacturer.
3. **Ignition System.** I will launch my rockets with an electrical launch system and electrical motor igniters. My launch system will have a safety interlock in series with the launch switch, and will use a launch switch that returns to the "off" position when released.
4. **Misfires.** If my rocket does not launch when I press the button of my electrical launch system, I will remove the launcher's safety interlock or disconnect its battery, and will wait 60 seconds after the last launch attempt before allowing anyone to approach the rocket.
5. **Launch Safety.** I will use a countdown before launch, and will ensure that everyone is paying attention and is a safe distance of at least 15 feet away when I launch rockets with D motors or smaller, and 30 feet when I launch larger rockets. If I am uncertain about the safety or stability of an untested rocket, I will check the stability before flight and will fly it only after warning spectators and clearing them away to a safe distance. When conducting a simultaneous launch of more than ten rockets I will observe a safe distance of 1.5 times the maximum expected altitude of any launched rocket.
6. **Launcher.** I will launch my rocket from a launch rod, tower, or rail that is pointed to within 30 degrees of the vertical to ensure that the rocket flies nearly straight up, and I will use a blast deflector to prevent the motor's exhaust from hitting the ground. To prevent accidental eye injury, I will place launchers so that the end of the launch rod is above eye level or will cap the end of the rod when it is not in use.
7. **Size.** My model rocket will not weigh more than 1,500 grams (53 ounces) at liftoff and will not contain more than 125 grams (4.4 ounces) of propellant or 320 N-sec (71.9 pound-seconds) of total impulse.
8. **Flight Safety.** I will not launch my rocket at targets, into clouds, or near airplanes, and will not put any flammable or explosive payload in my rocket.
9. **Launch Site.** I will launch my rocket outdoors, in an open area at least as large as shown in the accompanying table [below], and in safe weather conditions with wind speeds no greater than 20 miles per hour. I will ensure that there is no dry grass close to the launch pad, and that the launch site does not present risk of grass fires.

10. **Recovery System.** I will use a recovery system such as a streamer or parachute in my rocket so that it returns safely and undamaged and can be flown again, and I will use only flame-resistant or fireproof recovery system wadding in my rocket.
11. **Recovery Safety.** I will not attempt to recover my rocket from power lines, tall trees, or other dangerous places.

Most of all, be safe and launch for the field size, NOT the rocket size.		
LAUNCH SITE DIMENSIONS		
Installed Total Impulse (N-sec)	Equivalent Motor Type	Minimum Site Dimensions (ft.)
0.00--1.25	1/4A, 1/2A	50
1.26--2.50	A	100
2.51--5.00	B	200
5.01--10.00	C	400
10.01--20.00	D	500
20.01--40.00	E	1,000
40.01--80.00	F	1,000
80.01--160.00	G	1,000
160.01--320.00	Two Gs	1,500

Design Options

Clustering

Clustering, or using two or more rocket motors at once, allows you to lift heavier rockets and payloads off of the ground. Clustering black powder motors requires a launch controller that supplies at least 12 Volts DC (VDC) to the igniters to ensure all of the motors ignite at the same time. When clustering, keep the motors as close to the center line of the rocket as you can. If one or more motors fail to light the flight will at least have a lower apogee. Some rockets deploy the recovery system too low or after the rocket is on the ground, and others slam into the ground under power. These are some of the unforeseen problems you can encounter when clustering.

When clustering motors together with different nozzle diameters, the smaller diameter(s) ignite first, followed by the larger diameter.

(Continued on next page.)

The rocket below clusters two C6-7 and one D12-5 and uses friction motor mounts. The C6-7 engines light first, followed by the D12-5. The picture on the left shows a successful flight in which all three motors are inline and lit. The picture on the right shows two of the motors lit in the rocket during an unsuccessful flight. Unfortunately, during this particular launch the owner forgot to friction mount the D12-5 in the center. The C6-7 engines lit first and left the D12-5 behind. You can see the D12-5 engine lit in the smoke below the rocket. Just after this picture was taken the rocket was struck by the D12-5, flipped over, and slammed into the ground.



Ohio State University Extension



Ohio State University Extension



Ohio State University Extension



Ohio State University Extension

Here are a few typical clustering arrangements. Note that if your fins are located in line with motors your rocket will be structurally stronger.

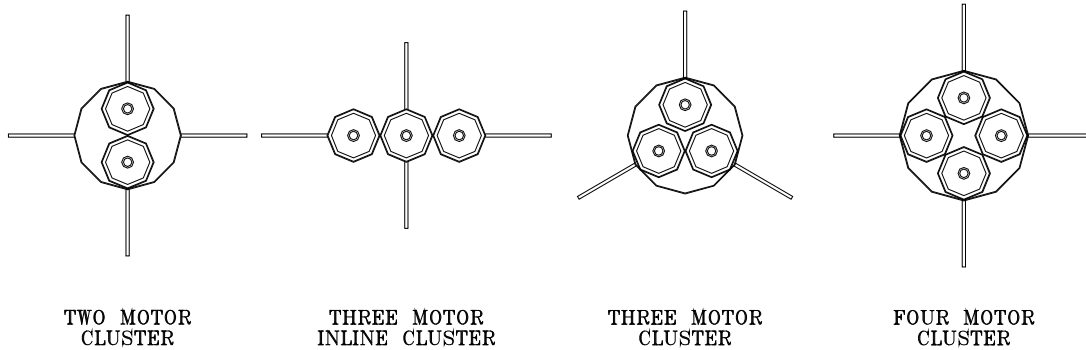

Ohio State University Extension

Staging

Staging allows you to increase the performance of the rocket by increasing the rocket's total impulse and decreasing the rocket's final weight. A staged rocket has two or more motors that burn one after the other while dropping off the used booster(s), where the booster consists of the motor with its associated airframe.

Different types of solid propellant motors are available and discussed within this book. Black powder rockets are suggested for staging model rockets. Staged rockets with black powder engines can be launched with standard 6 or 9 VDC launch controllers. Composite motors can be staged; however, these motors require electronic timers, altimeters, G-switches, or combinations of these additional pieces of equipment. Composite motors also require at least a 12 VDC launch controllers. As a result, staging composite motors is not recommended for this project.

When staging engines together, an additional degree of risk is introduced to your model rocket during launch. If you have a misfire on a single stage rocket, the rocket will still be on the Launchpad. You can just replace the igniter and launch with no harm done to the rocket. However, if a two stage rocket misfires on the second stage, the rocket will fall nose first from 400 to 600 feet without a recovery system deployed. The result will be that your rocket will be considerably shorter after the flight. Once the rocket leaves the pad you will have no control over it. As a result, be advised that upper stage misfires can and sometimes will happen when staging rockets.

Remember to mark the CG and CP locations for all stages of your rocket. For example, if you have a two stage rocket, it will have two CGs and two CPs marked on the rocket; one for the sustainer section, and one for both stages assembled and ready for launch.

Compound Staging

Compound staging incorporates both clustering and staging and come with all of the inherent problems of both.

The rocket shown below was built for a rocket challenge by high school students; the challenge was to launch two eggs 2,000 feet. It had to carry an altimeter and have at least two stages. The booster carried two D12-3's and a D12-0 with parachutes, the sustainer carried a E9-5 and a 24" nylon parachute. This is where bigger was required to lift the two egg payload.



Ohio State University Extension

Parallel Staging

Parallel staging closely resembles clustering but the sustainer has a longer burn time (E9-6) the boosters have more thrust but a shorter burn (D12-3's). The boosters are ejected after their burn time and in this case have their own recovery systems. This is usually controlled by timers or altimeters, but it also can be done by other means.

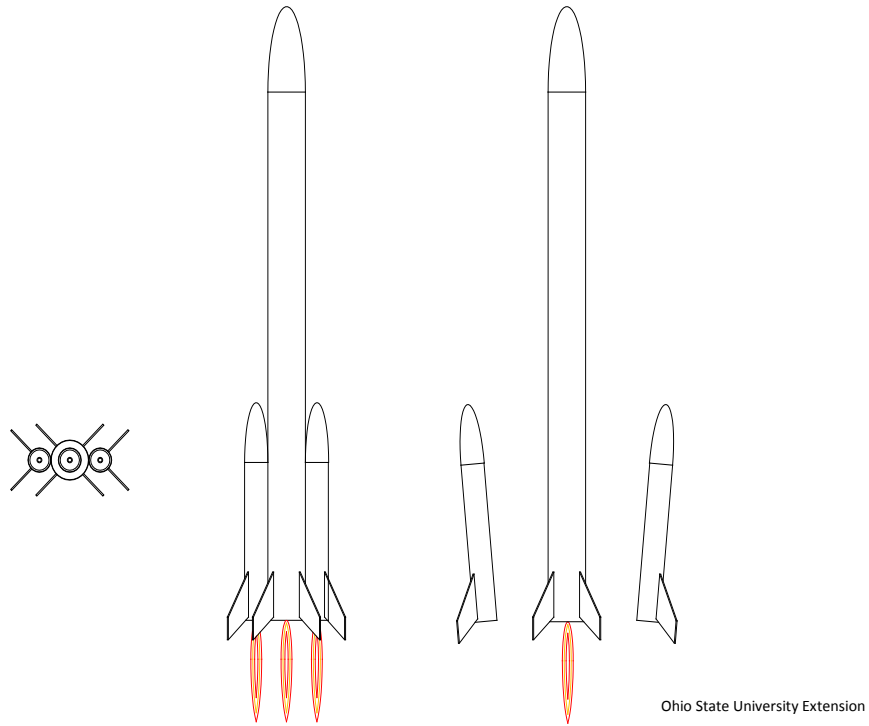

Staged clusters

Using staged clusters involves air-starting the additional motors. Note that on the rocket on the left, the first phase has four motors and three in the second. The rocket on the right has three in the first phase, three in the second, and one in the third. The spent motors are still carried by the rocket along with the additional drag of the larger body tube to house them. This is controlled by using either timers or altimeters.

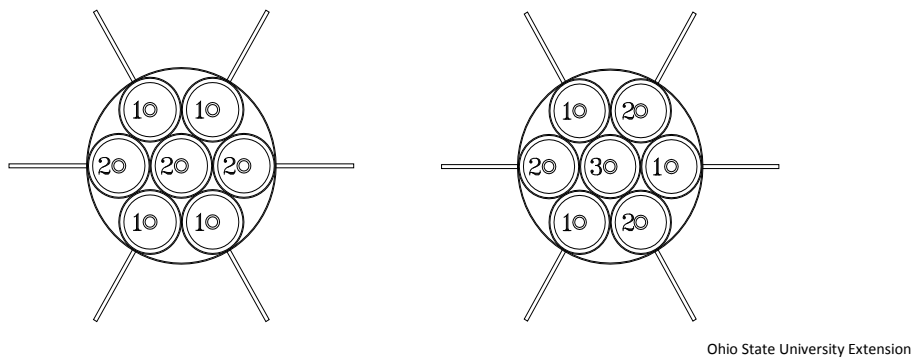

Fins

Balsa wood fins are adequate for all forces exerted on a rocket using black powder motors, but only if the wood grain is running in the proper direction. When laying out your fins on your material, pay close attention to the direction of the wood grain. The most efficient way to save material is often incorrect. Fins with the grain running parallel to the body tube break under the stresses of flight. (See drawing labeled "Incorrect.") With most fins, the grain running with the leading edge is much stronger. (See drawing labeled "Correct.") Grain direction is important for balsa or basswood fins only; if you are using plywood fins it is not an issue.

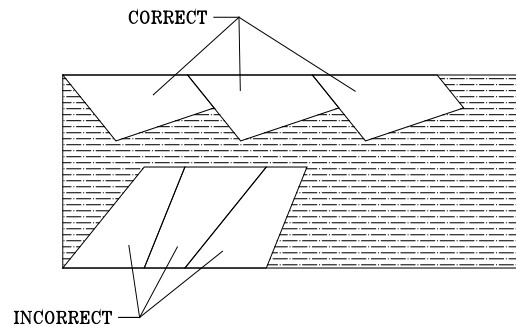
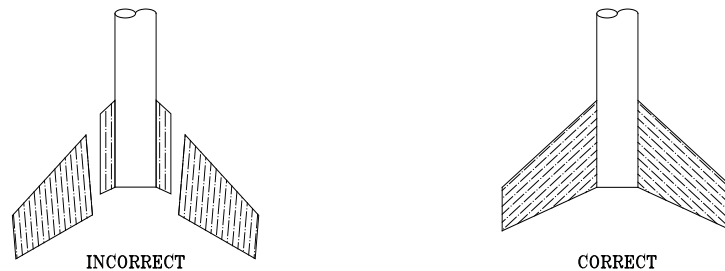

Ohio State University Extension

For composite motors you must either 1) reinforce the balsa wood by painting the raw wood with CA glue, or 2) change material to basswood or plywood. Reinforced balsa fins are structurally strong but are difficult to sand to a smooth finish.

These images show the best direction of the grain for various fin types.

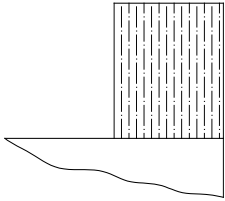

RECTANGULAR

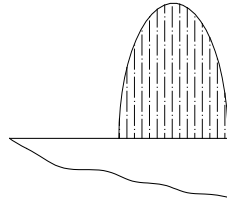

ELLIPTICAL

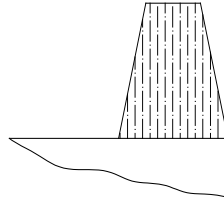

TRAPEZOIDAL

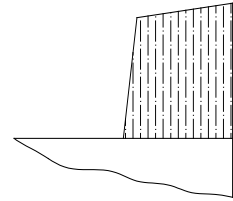

RAKED

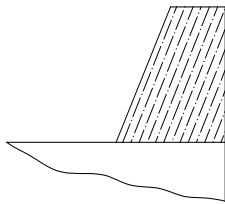

CLIPPED DELTA

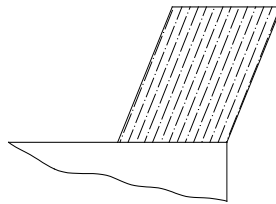

SWEPT

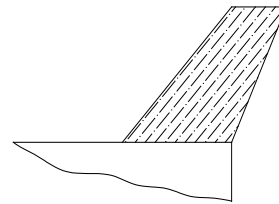

TAPERED SWEPT

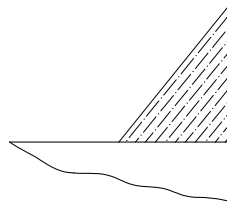

DELTA

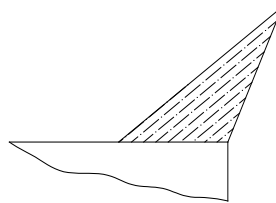

SWEPT DELTA

Ohio State University Extension

Nose Cone Options

Options for nose cones include the ones pictured below and others, all of which create certain amounts of drag. The ones pictured here are arranged in order of increasing drag, with the drag coefficients appearing below each drawing. As you design your rocket, be aware that there is more to nose cone selection than appearance.

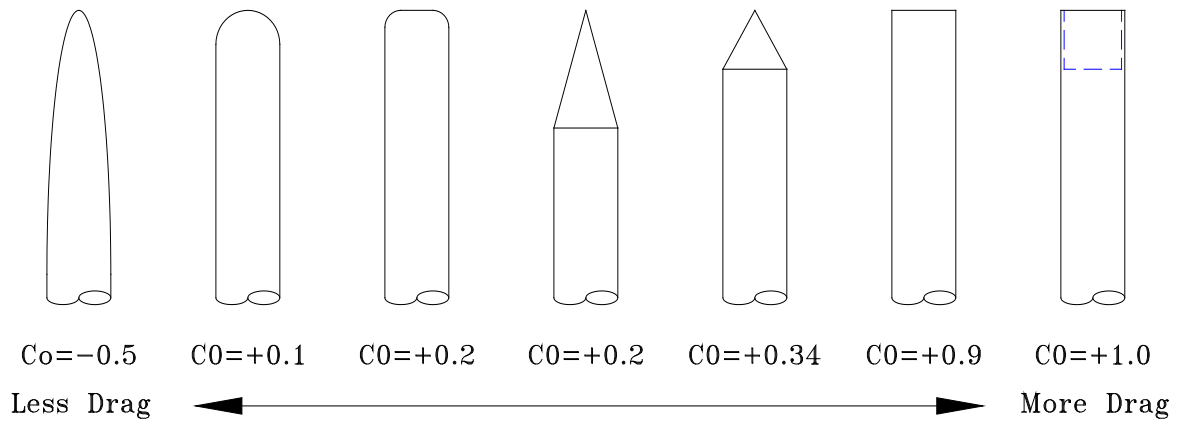

Ohio State University Extension

Base Options

Larger diameter rockets have a large amount of base drag inherent the design. Adding a boat tail can decrease the base drag of your rocket. A boat tail is a reducer section in which the smaller diameter faces the back of the rocket. Be careful if you are adding a boat tail to a short stubby rocket—some of these designs rely on base drag as part of their stability.

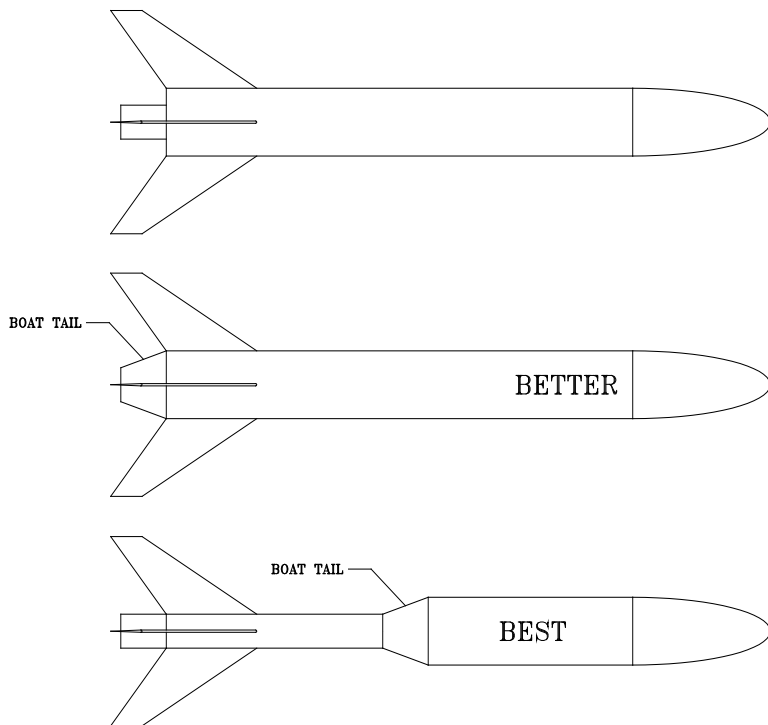

Ohio State University Extension

Electronics

Many electronic devices can be incorporated into a model rocket. Listed below are just a few electronic options you can consider.

Timers

Timers initiate an event such as recovery system deployment staging, air start of additional motors in a cluster, or parallel staging. Timers are initiated by an event such as a loss of continuity at launch. After the timer is powered, once the circuit is broken the event happens in however many seconds the timer is set to. Sometimes the motion of carrying a rocket to the launch pad ignites the second stage. For this reason timers should be powered on and set only on the launch pad.

Altimeters

Altimeters range from simple devices that tell you the rocket's altitude at its apex to more complex units that deploy recovery systems, air start of additional motors in a cluster or parallel staging, staging of composite motors, and data recording of the entire flight downloadable to your computer. Some units have G-switches that do not initiate an event until it senses the Gs associated with the rocket's launch. Altimeters also should be powered only while on the launch pad.

Cameras

For many years cameras and video cameras have been incorporated into model rocketry. Now, with the introduction of digital cameras, light-weight and rugged cameras are available at a reasonable price.

Locators

After being armed, a "sonic locator" emits a very loud chirp. Some also include flashing beacons. A "radio locator" allows you to find your rocket using a hand-held receiver. This electronic device makes locating your rocket easier. However, if you are consistently losing your rockets, make sure your launch area is at least as big as suggested by the model rocket launch site requirements. You may need to find a larger launch site.

Lighting

With the addition of LEDs (light emitting diodes) some rockets have been equipped with flashing lights. If you plan to launch a rocket at night, please note that to avoid being in violation of FAA (Federal Aviation Administration) regulations, your rocket must weigh less than 16 ounces (1 pound) at liftoff.

Stability

Stability is one of the most important factors to consider when designing your own rocket. In the Ohio 4-H 503 *Rockets Away* project, when you built from a kit and followed the manufacturer's instructions, stability was not a concern. Manufactured kits are pre-tested for stability. Since you are not building a manufactured kit for this project, you must show your rocket is stable prior to launch.

Never launch a rocket until after its stability has been proven.

Proving your rocket is stable involves determining the center of gravity (CG) and center of pressure (CP), also known as the point of pressure. If you have a multistage rocket, you must find all of the CG and CP locations and show that each stage is stable. Also, don't forget to test your rocket for stability after you have painted it and applied any decals. Both can change a rocket's stability.

Center of Gravity

The center of gravity is found by finding the balancing point of the prepared rocket. A prepared rocket is "ready launch." This means your rocket is finished and painted, the recovery system is properly prepared for flight, and an engine is loaded in your rocket. **The engine is not to be armed while finding the CG location of your rocket.** Mark the CG location on your rocket.

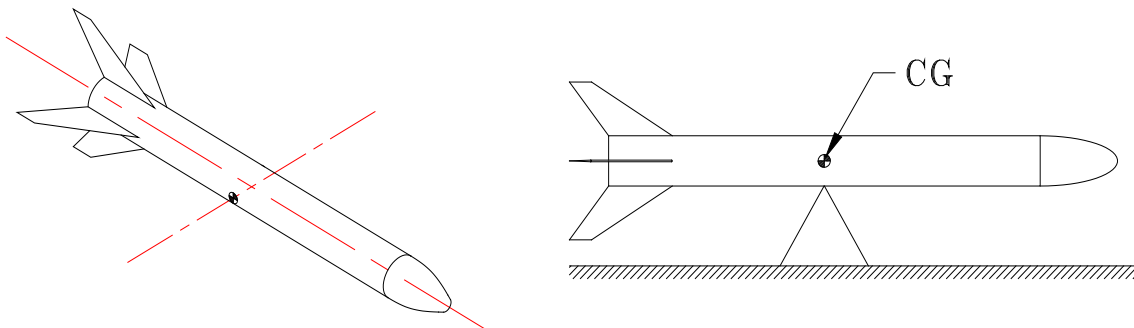

Ohio State University Extension

Center of Pressure (CP) or Point of Pressure

You can find the point of pressure using one of these three methods:

- The Barrowman Method, which is not explained here, involves mathematical calculations. If you choose to use this method you are expected to show your work.
- Model rocket software programs, which are not explained here, are readily available. If you use this method you are expected to show a printout of this information.
- The cardboard cutout method, described below, works fine for most rockets. This method is the simplest, but it has its limitations with complex designs relying on base drag or other more

complex methods to increase stability. (It can show “false” stability issues.) If you use this method you are expected to bring your cutout with CP location marked.

Cardboard Cutout Method

1. Start by drawing your rocket “full size” on a piece of cardboard or foam poster board. Start with the length and width of the body tube, and then trace the fins and nose cone. Ensure that the cardboard or foam poster is strong enough to keep from bending. For long models, thin wood may be required.
2. Carefully cut out the drawing.
3. Find the balancing point of the cutout. This is the CP, or point of pressure.
4. Mark the point of pressure on the cutout.
5. Measure the point of pressure from the base of the cutout and transfer it to your rocket.

Divide the largest diameter of your rocket in half. Compare the half-diameter length to the length between the CG and CP locations you found on your rocket. If the GG is at least this half-diameter length in front of the CP, your rocket is stable.

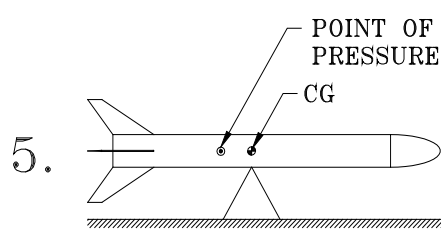
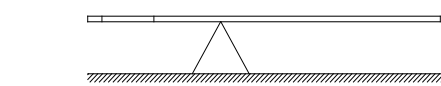
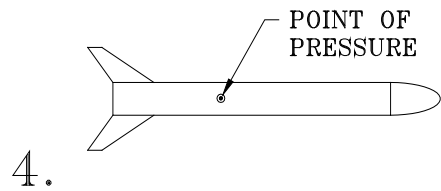
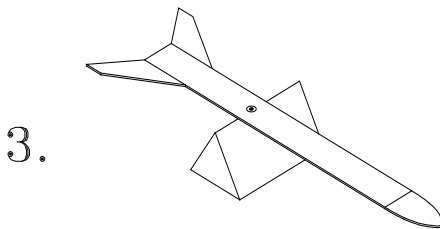
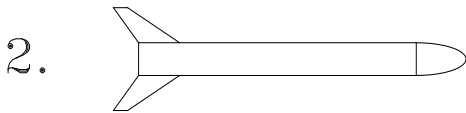
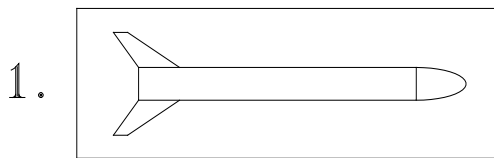

Ohio State University Extension

Swing Test for Stability

One of the best ways to test the stability of a model rocket is with a “swing test.” The steps for conducting a swing test are below, but remember, when you swing the rocket, make sure you are in an open area away from any people or objects.

1. Prepare the rocket by packing the recovery system, including recovery wadding, in your rocket. Then place the heaviest rocket motor that will fit in your rocket. (For example, place a C6-5 instead of an A8-3.) **No igniter is inserted in the motor for this test.**
2. Tie a loop in one end of 6-10 feet piece of string. Tie it around the body tube where the rocket balances horizontally (90° from the string). Place a piece of tape to keep the string from sliding off the CG.
3. Start swinging the rocket overhead with the nose cone facing forward. It may take several attempts to get the rocket to start this way. If the rocket continues to face forward, continue to step 4. If the rocket tries to turn around backward, stop the test, and add weight to the nose. This usually can be done by packing some clay into the nose cone. Then repeat steps 1-3.
4. Loosen the tape and move the string towards the back of the rocket until the nose points down 10° from horizontal then re-tape the string.
5. Start swinging the rocket overhead with the nose cone facing forward just like before. If the rocket continues to face forward you have a stable rocket. If the rocket tries to turn around backward, stop the test, and add weight to the nose. Then repeat steps 4 and 5.

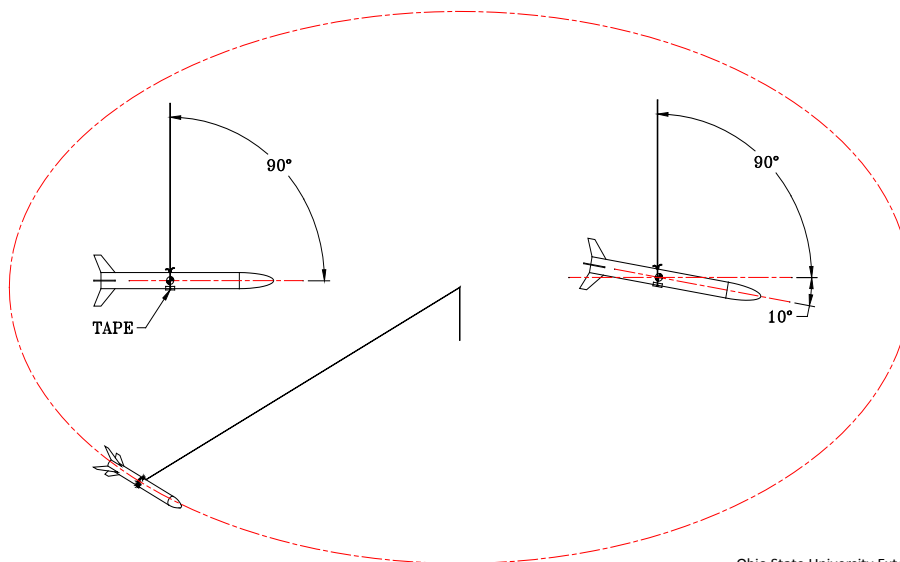

Ohio State University Extension

Additional Information for Review

Model Rocket Motors

Black Powder Motors

The most commonly used small model rocket motors are the black powder. These are the "traditional" model rocket motors that have been in production since the 1950s. Black powder model rocket motors are made of a paper tube with a clay nozzle, a solid pellet of black powder propellant, a smoke/delay charge, and an ejection charge.

Single-Use Composite Motors

Single-use composite model rocket motors are made from a high temperature plastic and use fuel that is a pellet of a rubber-like material similar to that used in space shuttle booster motors. The fuel in a composite motor is about three times as powerful as black powder, thus motors of equivalent power can be made in a smaller physical size. The internal components of a composite motor are much the same as a black powder motor, except that the nozzle and body of the motor is molded from a high-temperature plastic. The motor body contains the fuel, a smoke/timer charge, and the ejection charge.

Reloadable Composite Motors

Reloadable composite motors are essentially the same as single-use composite motors. They use the same fuel, timing charge, and ejection charge. However, reloadable composite motors are assembled in a reusable aluminum case. After the aluminum casing has been cleaned, it can be reassembled with a new nozzle, fuel, delay charge, and ejection charge, and used again. **This type of motor should not be used in this project.**

Hybrid Motors

A hybrid motor works with two different states of matter, one solid and the other either a gas or liquid. The simplest form of a hybrid rocket consists of a pressure tank containing the liquid propellant, the combustion chamber with the solid propellant, and the valve isolating the two. When thrust is desired, an ignition source is introduced into the combustion chamber and the valve is opened. The liquid propellant flows into the combustion chamber where it is vaporized and then reacts with the solid propellant. **Rockets using hybrid motors become less stable as the propellant is depleted. This type of motor should not be used in this project.**

Adhesive Types

Model rockets can be assembled using a variety of adhesive types based upon application. The following explains a few of the most common adhesives that can be used to assemble your model rocket.

Cement for Plastic Models (Model Airplane Glue)

Model airplane glue is commonly used to glue nose cone pieces together. This type of glue softens the plastic parts. When the parts are pressed together the plastic flows together and welds. This type of glue

should be used only in well-ventilated areas. There is a non-toxic version of this glue that does not soften and weld the pieces together. The bond is made by the glue drying and tends to fail due to the stresses placed on the rocket in flight. Non-toxic cement for plastic models should not be used in your model rocket.

White Glue

White glue is exceptionally strong when used on paper products, wood, and other porous materials, but does not work on plastic. The long drying time is the biggest complaint for this type of glue. You also may have trouble getting some types of paint to adhere to the white glue fillets.

Aliphatic Resin Glue

Aliphatic resin glue looks like a brownish-yellow version of white glue. This glue is very strong, dries faster than white glue, and most paint adheres to it. Like white glue, aliphatic resin glue works on paper products, wood, and other porous materials, but does not work on plastic.

Contact Cement

Contact cement is a quick way of bonding two pieces together. To use this type of glue, apply a thin coat to both surfaces, let the pieces set for a few minutes, and then carefully join the two pieces. These pieces will be bonded instantly and you will not be able to readjust them. As a result, accuracy is extremely important when using this type of adhesive. Contact cement works on almost any material.

Epoxy

Epoxy is a strong to exceptionally strong adhesive. This type of adhesive bonds anything except Teflon and some types of PVC (polyvinylchloride). Epoxies have curing times that range from 60 seconds to 24 hours. A longer cure time equates to a stronger epoxy. Read the label and know the working time and cure time for the epoxy you are using. Five-minute epoxy sets and cures in 5 minutes; 30 minute epoxy has a working time of 30 minutes and a cure time of 24 hours. Epoxy can be messy so take appropriate measures.

CA Glue (Cyanoacrylate)

CA glue has almost an instant cure and bonds anything to anything. It is great for quick repairs at the launch site. CA glue should only be used in a well-ventilated area as the fumes can be very irritating.

Warning: CA glue will bond skin instantly to anything (fingers to fingers, finger to thumb, finger to rocket, finger to glue bottle, etc.). If you are using CA glue, keep a bottle of de-bonder nearby.

“CA Accelerators” speed up the curing of CA glues. These accelerators generate a lot of heat due to a chemical reaction with the CA glue. When using accelerators you can glue fingers together *and* burn them! Cotton fibers can react with some CA Glues, so cotton swabs or cotton balls should not be used with CA Glue.

Finishing

Wooden fins should be sealed by using balsa filler coat or sanding sealer. The object is to fill in as much of the wood grain as possible, allowing for a smooth and professional finish on your rocket. Balsa filler coat and sanding sealer are applied in the same manner. This section refers to sanding sealer in all instructions.



Ohio State University Extension

1. Paint the sanding sealer on all exposed surfaces of your fins. It can be brushed or sprayed on. If you are spraying, mask the body tube of your rocket first. Let the sanding sealer dry completely.
2. Use a sanding block to gently sand the fins smooth.
3. Repeat steps 1 and 2 until the wood grain almost disappears. A lot of thin coats are better than a few thick ones.
4. After you are satisfied that the wood grain has been completely filled, spray a coat of primer on your rocket. Flat white paint can be used as primer. Flat paint dries quickly, shows any problems so you can fix them before proceeding, and bonds well with gloss paint used as the finish coat.
5. If you are happy with the primer, paint your finish coat of paint.

Plagiarism

The rocket below is from a kit called ACME Sptifire by model rocket producer Fliskits, Inc. Unfortunately this kit has been described as “my own design” and not as a modified kit on three different occasions at county fairs, even though all three times the parachute in the rocket was marked Fliskits. Because they claimed it was their own design, none of the youth involved received credit for building this very difficult rocket.

This rocket may look unstable, but it is actually a good flyer. This shows that with the correct center of gravity and increased base drag, by design, you can make almost anything stable.



Ohio State University Extension

Sample Rocket Projects

These modified or custom-designed rockets, some more successful than others, have been built mainly by 4-H members. Some designs have been more successful than others.

This rocket design was inspired by the first manmade satellite, Sputnik, and is roughly a half-scale model of the satellite. With the engine mounted so far forward, it is a slow, stable flyer using a D12-3. This example shows how you can use a real-world object as the basis of a rocket design and also how other materials can be used. This Sputnik model rocket was built using wooden dowel rods and a Styrofoam sphere.



Ohio State University Extension

This rocket was constructed from three 2-liter soda bottles. It had an internal PVC tee to deploy the recovery systems out of both sides. You can see the clay noseweight packed in the nose. This rocket flew on a D-12-3 and returned to the ground with two 18" parachutes.



Ohio State University Extension



Ohio State University Extension

This rocket had no fixed fins. The fins spin in flight and each section rotates opposite from the previous section. Note the launch lug is located internally to keep the fins from hitting the launch rod. Some rockets are too long to make a cardboard cutout due to the strength of cardboard, as was the case for this rocket. Notice the center of gravity and point of pressure marker on the plywood cutout.



Ohio State University Extension



Ohio State University Extension



Ohio State University Extension

The two rockets shown below were built from the same kit. The one on top was constructed according to the instructions. It uses 13mm motors (A10-0T booster and A10-3T sustainer). The one on the bottom was built to use 18mm motors (C6-0 booster and C6-7 sustainer). Notice the booster section is longer to accept longer motors.



Ohio State University Extension

The rocket below was constructed using Styrofoam cups. It has no fins, but three additional cups set in the bottom provide a large amount of base drag for stability. The motor mount is 24mm in size. Notice the straw used as a launch lug taped to the side of the rocket. During powered flight, the rocket tracked straight. However, nose weight was not added to ensure the rocket remained stable after the powered flight phase. During the time delay the rocket flipped around and continued to the apex backwards, before falling backwards to the ground. The parachute did not deploy until about ten feet from the ground.



Ohio State University Extension



Ohio State University Extension



Ohio State University Extension

These examples are provided to show that you can use real-world objects as the basis for your model rocket designs. The left image shows a water tower from a Lionel train set that was turned into a rocket. It flies well on a C6-3. The rocket in the right image is a scale model of a Beckham Natter, a World War II German rocket plane. If you build a scale historical rocket, know its history and be prepared to share it with the judges.



Ohio State University Extension



Ohio State University Extension

The rocket shown below is a two stage D12-0 to D12-7 with elliptical fins. The yellow rings were added to disguise the fact that the front of the rocket was destroyed the day before competition when the sustainer engine failed to light. The yellow decal ring closest to the fins is where the rocket had to be cut off. The upper portion of the rocket was rebuilt and painted prior to competition the next day.

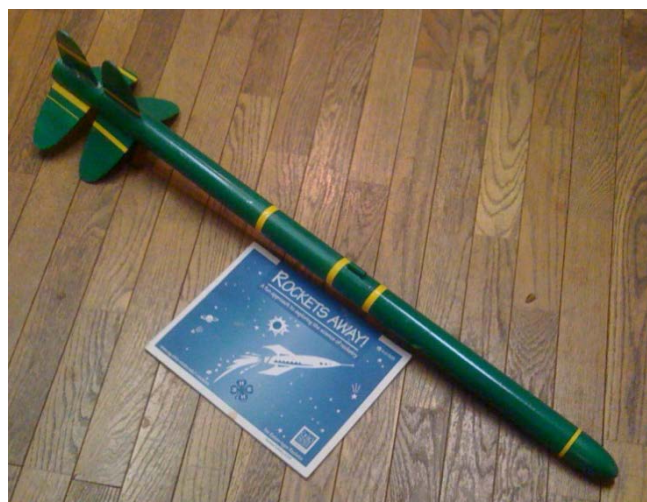

Ohio State University Extension

The rocket below is a two stage D12-0 to D12-7 with a parachutes recovery system in the booster section.



Ohio State University Extension



Ohio State University Extension

Design of the rocket below is based on a 2001 conceptual image of a replacement launch vehicle for the space shuttle and was built to use a single stage D12-3 engine. The fins are actually gliders that separate from the main body of the rocket when the main body parachute is deployed. All three parts of the recovery system have to work for the recovery system to be successful.



Ohio State University Extension



Ohio State University Extension

The rocket below was inspired by a box kite design. Like the Sputnik and the Water Tower, the engine is mounted high in the airframe, moving the center of gravity forward. This rocket was designed to be stable and was tested repeatedly prior to finishing. The rocket would track straight during the powered phase of flight. During the delay it would lean over and “glide” during the delay then deploy a 24” nylon parachute. Because of this unexpected glide the engine was changed from a D12-3 to a D12-5, then to a D12-7. After this the rocket was finished with three coats of sanding sealer and a coat of paint. The next launch of this rocket was at the county fair. Unfortunately the finish had changed the aerodynamics of the rocket. Instead of gliding down at 5° it came down a about 60° and hit the ground prior to the recovery system deploying.



Ohio State University Extension



Ohio State University Extension

Flying your rocket prior to finishing saves you the work if you lose it, but remember that the finish changes the boundary layer of your rocket and therefore its aerodynamics and performance.

This rocket was designed and a small prototype was built, as can be seen in the upper left image. The prototype was scaled up to the final size to accommodate some unique features. This rocket is a two stage (three D12-3s, one D12-0, and one E9-4). Three D12-3s are located at the root of each of the three legs and the ejection charges are routed out the legs to three parachutes located in the end of each leg. The D12-0 engine is located high in the center of the rocket and the sustainer is located in the center of the second stage. The second stage has wooden dowels with turkey feathers at the bottom (to provide stability during flight) and an 18" nylon parachute for a recovery system.



Ohio State University Extension



Ohio State University Extension



Ohio State University Extension



Ohio State University Extension

Unfortunately this rocket was housed in a building at the county fair where the roof leaked. It was built almost entirely from pizza boxes and the legs dissolved and lost their strength. The duct tape is holding together the damage from the water. It was an expensive rocket to launch, and all four motors were just enough to lift all this weight along with the massive amount of base drag.

This rocket, which is based on a pyramid design, is a two stage. It has (4) D12-0s in the booster and a D12-3 in the sustainer. There are three gliders that unhooked from the booster at staging. The fins are set at an angle to cause the rocket to rotate for added stability. The booster itself is very light, and it turned over and spun back down to the ground. On each side of the sustainer are two counter-rotating propellers. ("Because it looked cool," was the answer I got.) The recovery system for the sustainer is an 18" nylon parachute. This also was an expensive rocket to launch.



Ohio State University Extension

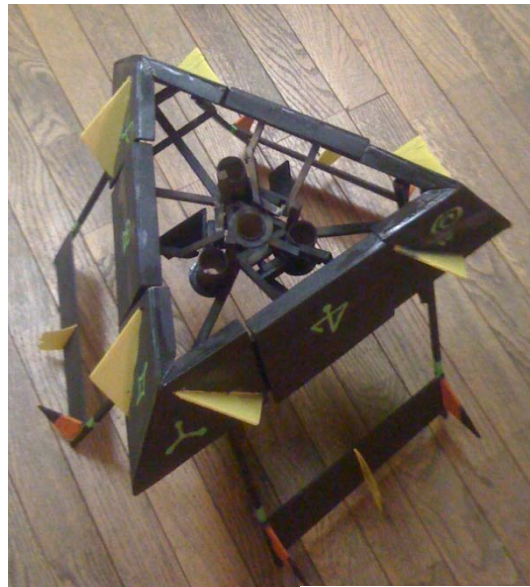

Ohio State University Extension



Ohio State University Extension



Ohio State University Extension

Additional Resources

4-H 503 Rockets Away (Solid-Fuel Model Rockets) by Robert L. Horton. This is the book that has given you the foundation you are now building on. Refer back to it as needed.

The Alpha Book of Model Rocketry by Estes Industries. This book is available online. (To find it, do an Internet search of the title.) Although the safety code is outdated and the photographs are right out of the 1970s, the information is straightforward, easy to understand, and very informative.

Handbook of Model Rocketry by G. Harry Stine. This is a great book for the more advanced rocketeer. It contains a huge amount of information and sections are appropriate from grade school to college.

50 Model Rocket Projects for the Evil Genius by Gavin D. J. Harper. This excellent reference book is easy to understand and has projects that include designs for finless saucer-style rockets, diagrams for simple and complex launch controllers, and even a wind tunnel design. **Do not include project 1 (Making Black Powder) as part of your 4H project.**

Model Rocket Design and Construction by Timothy S. Van Milligan